



User Manual

CGM MCB-1201



EHAN301020



Disposal of Old Electrical
& Electronic Equipment
Applicable in the European
Union and other European
countries with separate
collection systems.





0086



Important safety issues

This appliance is not intended for use by persons (including children) with reduced physical, sensory or mental capabilities, or lack of experience and knowledge, unless they have been given supervision or instruction concerning use of the appliance by a person responsible for their safety. Children should be supervised to ensure that they do not play with the appliance.

The information below stands to protect the safety of the user and to prevent any property damage. All users must read the manual and use the product appropriately. The important safety issues are divided into "Danger", "Warning" and "Caution" and their meanings are as follows. This picture is a symbol used to warn in case of dangerous situations or dangerous control methods.

 Danger	In case of violating the instructions, there is an emergent possibility of serious damage or even death.
 Warning	In case of violating the instructions, there is some possibility of serious injury or death.
 Caution	In case of violating the instructions, there is possibility of minor injury or property damage.

The least favorable working condition

The least favorable working condition is to use the thermal and massaging functions continuously while applying 135kg on the main mat and the auxiliary part.



Danger

 Be careful not to get burned from unintended use.

Please follow the instructions carefully in order to reduce potential electric shocks.

1. While using this product, do not use pins or other metals.
2. Do not use the product when there is humidity or water.
3. The external projector must be used with the external projector cover so that there is no direct contact between the product and skin. (There is risk of receiving a burn.)
4. To prevent damage to the eye (eyeball), do not place the external projector directly on the eye.
5. In case of thunder, lightning or an earthquake, please stop using the product and unplug it. (There is risk of receiving an electric shock or a burn.)
6. Do not pull the cord to unplug or touch the power plug with wet hands. (There is risk of receiving an electric shock or a burn.)
7. Apart from the mode for massaging the abdomen or the manual mode, do not use the product laying face down. (If the product is used lying down, do not use near the rib cage and only on the abdomen.)



Important safety issues



Warning

In order to prevent injuries from burns, fires and electric shocks, one must connect to a socket that has a ground connection. Be certain of how to connect to the socket before using the product.

1. Only use the product if it is in mechanically complete condition.
If damaged products are used, there is a possibility of injury or burns)
2. If you have finished using the product or will not use it for a long time, unplug the product.
3. Apart from the external projector cover provided by our company, do not place other products or substances on top that may cause fires (such as fiber products, blankets and etc.)
(Overheating can cause fires and electric shocks.)
4. In case of use by a disabled person or children, guardians must be present.
*Warning! Keep children away from where this product has been installed.
*Warning! Make sure that children do not jump on the thermal massage bed.
5. Do not use the product if they are in the conditions mentioned below. Call the customer center and request inspection or after-service.
 - If the product has been dropped or is damaged
 - If the product is wet
 - If the cord or the power button is damaged. (There is a risk of an electric shock or a fire.)
6. Keep the power cord away from electric heating appliances or heaters.
7. This product has only been designed for indoor use. Do not use it outdoors.
8. Do not use the product where there are foreign substances in the air or places that handle oxygen.
9. Do not use or apply skin care, cosmetic or medical products on your skin before and during the usage of this product.
10. Be cautious of heated surfaces. (Can cause severe burns)
11. Do not use the external projector on parts of the body that have low levels of sensitivity or parts that have reduced blood flow.
(The heat remaining from the product may be dangerous to children or those who are in bad health.)
12. Please do not sleep on the equipment.
13. Do not randomly disassemble, repair or remodel the product. Call the customer center when in need of a repair.
(There is a risk of electric shock, fire, injury, and burns.)
14. To avoid the risk of injury:
 - Pregnant women, people who have malignancies, high fever, osteoporosis, people in poor physical health, people in poor physical shape or undergoing any medical treatment, and people suffering back, neck, shoulder or hip pain should consult their doctor before using the product.
 - If you have a pacemaker, defibrillator, other artificial implants or other medical devices, consult with your doctor prior to use.
 - If you have sensitive reactions or allergy to heat, you should also consult your doctor before using the product.
 - Do not use on bare skin; always wear clothing.
 - Do not use if you have had any major surgeries, including back and/or hip surgeries.
 - Consult your doctor prior to use if you have any external wound(s) or infection(s) on the skin where the product will come into direct contact with your skin.



Important safety issues

- Immediately stop using the unit if you start to feel sick or uncomfortable, or if the massage seems too painful.
- As of now, there is no evidence to suggest that this product interferes with or influences medications. Those taking any prescribed medications should consult their doctor before using this product.
- Do not go to sleep while using the unit.
- Do not use the unit after drinking alcohol.
- Do not allow children or pets to play on or around the unit, especially during operation.



Caution

1. When using the internal projector, do not twist your body and use it with a straight posture.
2. When the product is set to high temperatures, there is a risk of burns, so set the projector's temperature at an optimal level. (Depending on the physical constitution or thickness of skin, use the product at optimal temperature.)
3. Those with sensitive skin must use the product at lower temperatures. (There is a risk of burns)
4. Children, those who cannot control the temperature by themselves, and those who have weak sensory skin must be cautious of using the product for an extended period even if it is set at a low temperature because there is risk of receiving a burn. (Warning! Please use while wearing clothing.)
5. If there are any abnormal symptoms while using the product, you must consult a doctor before using it again.
6. Do not bend the power cord or the outer wiring by force. (There is a risk of electric shocks and fires.)
7. Do not place flammable objects (candles, cigarettes and alcohol), objects with water in them, heavy objects or sharp objects on top of the product. (They can cause electric shocks and damage.)
8. When climbing on or off the product, be cautious of the risk of falling.
9. Use according to the instruction manual and keep to the duration and methods instructed in the manual. (Use 1~2 times a day and do not use other products unless supplied by the manufacturer.)
10. Do not use the external projector(s) for more than 2~3 minutes on one part of the body. (The projector must be moved to another part of the body after 2~3 minutes.)
11. Do not apply shock to the product.
12. Do not throw the remote control and swing or swirl the connecting cable. (It can cause the injury and equipment failure.)
13. When you move or store the product, take care not to throw down it. (It can cause the injury and equipment failure.)
14. The appliance has a heated surface. Persons insensitive to heat must be careful when using the appliance.
15. Do not jump on the product. (It can cause the injury and equipment failure.)
16. The Automatic Thermal Massager is intended for muscle relaxation therapy by delivering heat and a soothing massage to the applied areas.

※ Important information on symptoms

In some cases there may appear a so-called "initial aggravation". This initial aggravation may begin with a subjective increase of symptoms prior to the desired healing. The effect of initial aggravation is also known from other treatments (for e.g. the science of homoeopathy), which is defined as the reaction of healing and / or the clearing of blockages. The initial aggravation that may occur does not constitute an exclusion criterion of the application of product.

In the case of excessive pain related to pre-existing spinal conditions, distinct hypertension, cardiovascular diseases or dizziness, please first reduce the intensity of usage (duration & temperature).

In cases in which the initial worsening leads to excessive continual pain please stop the therapy and consult a medical doctor immediately to clarify if and under which circumstances the therapy can be continued or ceased.



Ground connection method

This product must be connected to a ground connection.

The ground connection reduces resistance against electric currents in case there are any defects or breakdowns which may lead to electric shocks and damage. On the product, there are conductors and electric terminals where the power cord is located. The power cord has been installed to comply with regional laws; therefore it must be connected to where there is a socket.



Danger

Check the connection of the product.
(Inappropriate connection may lead to electric shock and damage.)

If you suspect that the product's power cord and connection point has a problem, request investigation from an electrician or service personnel. This product is for 100-240V~ and the power terminal is installed as can be seen in the picture on the right. Connect the power cord to a socket that looks like the one shown in the picture. This product does not use an adaptor.

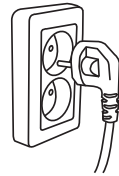

Notice to users

This device complies with Part 15 of the FCC Rules. Operation is subject to the following two conditions: (1) this device may not cause harmful interference, and (2) this device must accept any interference received, including interference that may cause undesired operation.

NOTE: This equipment has been tested and found to comply with the limit for a Class B digital device, pursuant to Part 15 of the FCC Rules. These limits are designed to provide reasonable protection against harmful interference in a residential installation. This equipment generates, uses and can radiate radio frequency energy and, if not installed and used in accordance with the instructions, may cause harmful interference to radio communications. However, there is no guarantee that interference will not occur in a particular installation, which can be determined by turning the equipment off and on, the user is encouraged to try to correct the interference by one or more of the following measures:

- Reorient or relocate the receiving antenna.
- Increase the separation between the equipment and receiver.
- Connect the equipment into an outlet on a circuit different from that to which the receiver is connected.



Caution

- Changes or modifications not expressly approved by the party responsible for compliance could void the user's authority to operate the equipment.

Contents

>> Important Safety Issues 01

- Danger
- Warning
- Caution

I. Introduction of the product 07

1. Product's characteristics
2. The name of each part

II. Installation and preparation 11

1. Check product's composition
2. Check before product installation
3. Installation
4. Check after installation

III. Using the product 17

1. Remote control layout
2. How to use the remote control
3. How to use the product (by mode)
4. How to move the product

IV. Management and matters that require attention ---- 31

1. Self inspection
2. Management techniques and storage methods
3. Check before A/S request
4. Remote control error messages
5. Product specifications
6. Product warranty

V. Service manual 39

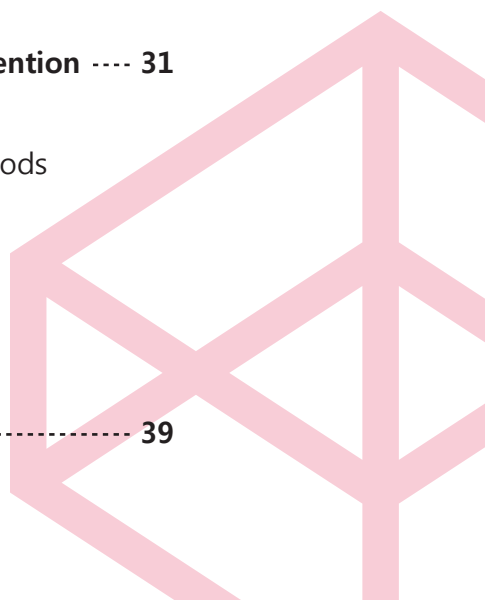

MEMO

A series of horizontal dashed lines for writing.

I . Introduction of the product

1. Product's characteristics
2. The name of each part





1. Product's characteristics

1. Aesthetically Pleasing, Easy-To-Use Exterior Design

The aesthetically pleasing, easy-to-use exterior design matches well with any home interior article. The folding design of the supporting mat requires minimum space and ensures convenience for the user.

2. Body sensing function

The new body sensing function automatically measures the length of the spine of the user, offering optimal, customized compressive stimulation.

3. Easy-To-Move Casters Installed

When the product is not in use, you can easily move and store it by using the casters installed underneath.

4. Diverse Stimulation Programs

The different stimulation programs created based on the concept of alternative medicine allow users to select programs that b needs.

5. Slim, Easy-To-Use Remote Control

The slim and light remote control has function keys in the form of icons for more convenient product operation and simpler manipulation. Moreover, with its acceptable-type design for the main body, the risk of loss is minimized.

6. External Projectors (3-Sphere) Provided

External projectors that can be used while this massaging equipment is operated are provided as basic components; users may use the external projectors for the abdomen, shoulders, arms, legs, and other body parts.



2. The name of each part

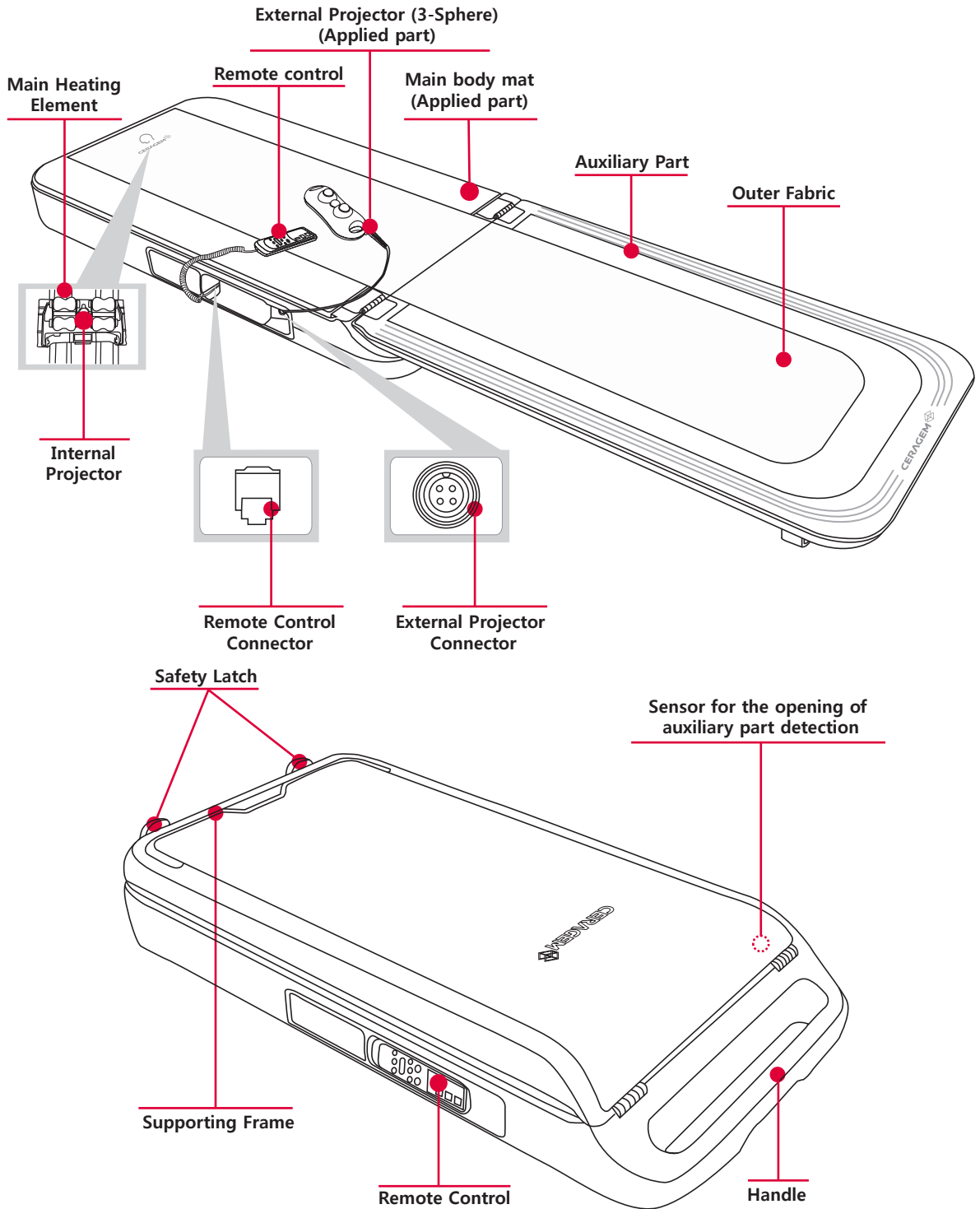

*Sensor for the opening of auxiliary part detection : It detects that the auxiliary part is open. When the sensor is separated from the body (when you lift or close the auxiliary part), however, it does not work.

MEMO

A series of horizontal dashed lines for writing.







II. Installation and preparation

1. Check product's composition
2. Check before product installation
3. Installation
4. Check after installation

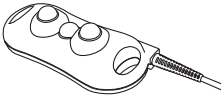
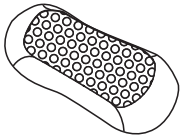

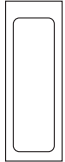

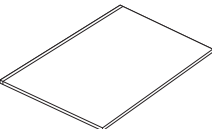
1. Check product's composition

1		<p>External projectors (3-Sphere) Easy to use on body parts such as the abdomen, shoulders, arms, legs and etc. Can be used with the main product or shared between two people.</p>
2		<p>External projector cover It can be used while covering the external projector.</p>
3		<p>Remote control Simple to operate and check the product's status.</p>
4		<p>Remote control cable To use the remote control, connect it to the main body.</p>
5		<p>Remote control back label Describes the remote control button layout, and can be attached to the back of the remote control.</p>
6		<p>Power cord Connects with the main body and plugs into an outlet for use.</p>
7		<p>User manual Information on how to use the product.</p>
8		<p>Outer fabric Protects the product from pollution and prevents burns. Easy to wash as it is detachable.</p>



2. Check before product installation

1. Install where the ground is flat to avoid the risk of damaging the product.

2. Try and avoid installation where there is a lot of humidity or dust.
(To avoid risking electric shocks or fire.)

3. Install according to the designated order.

4. When installing, check that the rated voltage is 100-240V~
(To avoid circuit damage or fire.)

5. Do not drop the product or apply any force to it.
(This could cause malfunctioning.)

6. Do not use damaged power cords, plugs or old sockets.

7. You must connect to a socket with a connection terminal.
(To avoid risking electric shocks.)



3. Installation

1

Take out the product and components from the box. Components

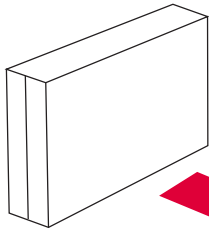

Accessories

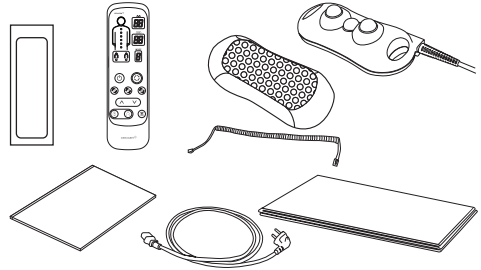

2

Lay the product where the ground is flat and unlock the safety latch.

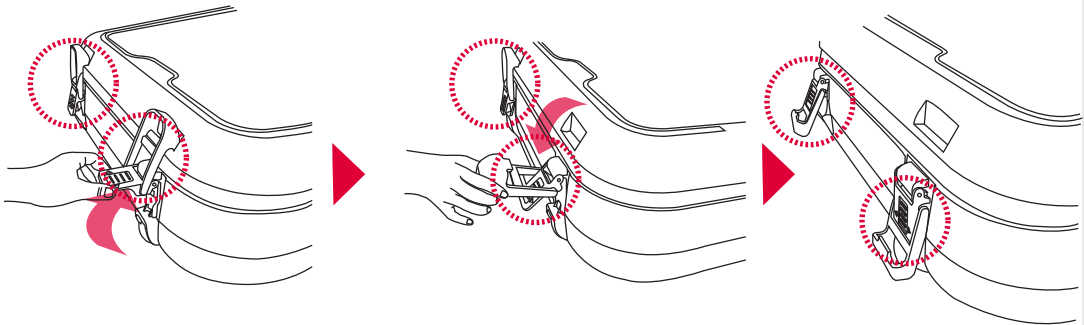

3

Open the product using the supporting frame.

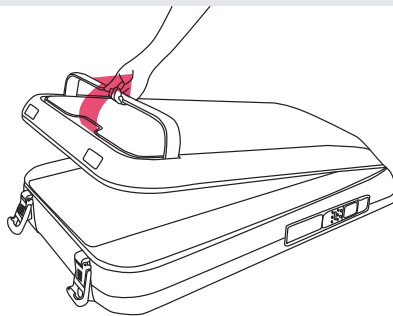

Take care not to insert any part of your body into the product when opening the product.
(There is risk of injury.)

Caution

The supporting frame cannot open somewhat smoothly for safety reasons.



3. Installation

4

Connect the outer fabric, remote control, and external projector properly.

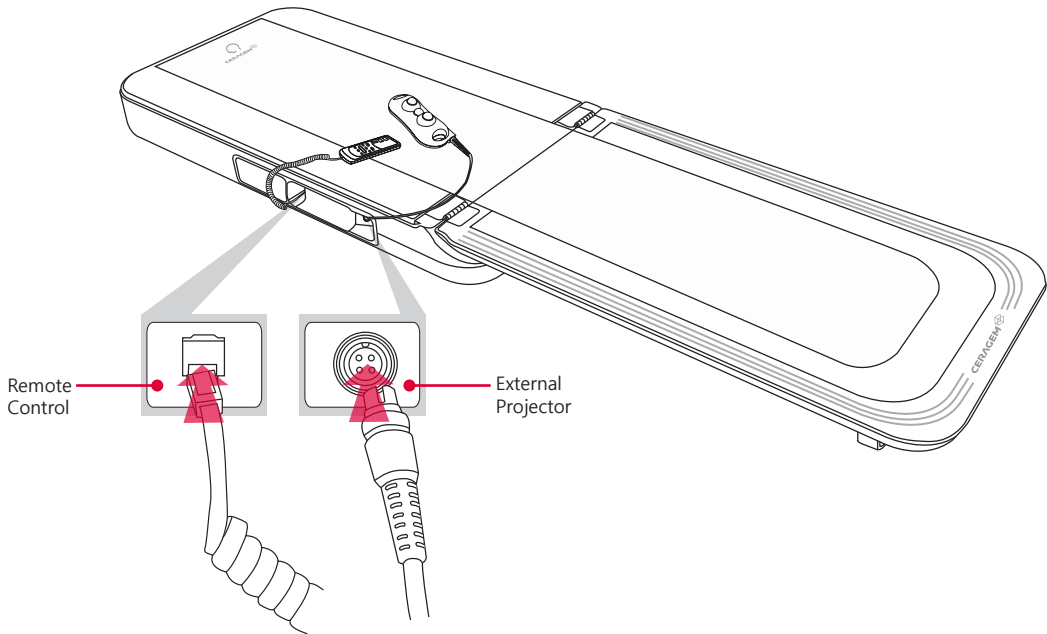

Warning

Do not touch the connector pin.
(Can cause bodily harm or mechanical failure.)

5

Connect the power cord onto the main body and plug into a socket.

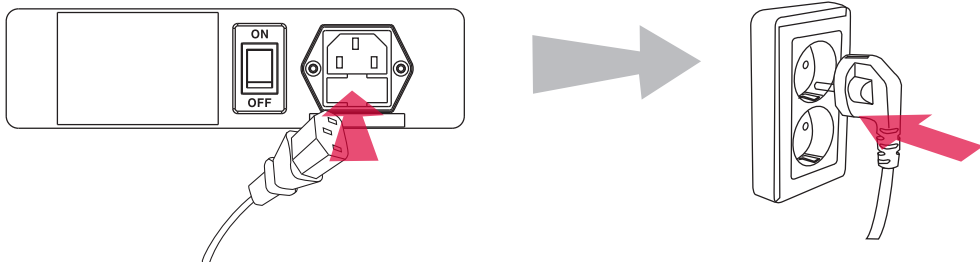

Caution

If the power cord is connected when the power switch is "On", it can cause mechanical failure.



4. Check after Installation

1

Unfold the auxiliary part completely.
(The remote control will not work unless you unfold the auxiliary part.)

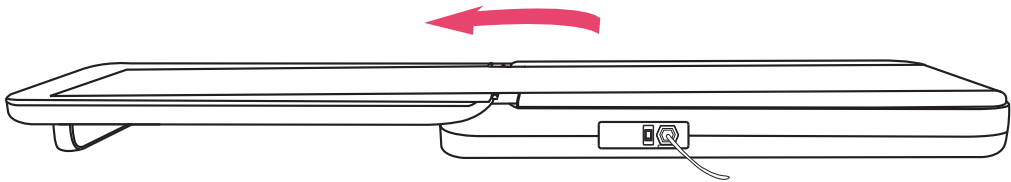

2

Turn on power at the side of the main body.
(Turn off power when the product is not in use.)

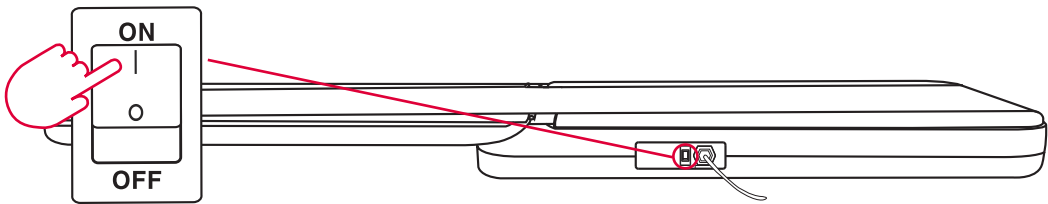

3

Press the power key of the remote control and check whether the display turns on.

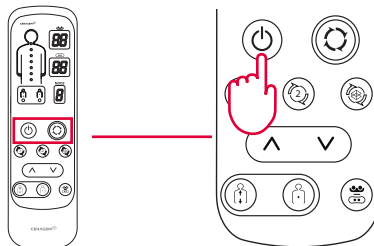

*For the remote control's screen, refer to page 19.



Caution

1. Before connecting the power cord, connect the remote control first.
2. Set the temperature appropriately according to user when using the product.
3. After using the product, turn off power on the remote control, and then turn off the main body.

III. Using the Product

1. Remote control layout
2. How to use the remote control
3. How to use the product by mode
4. How to move the product

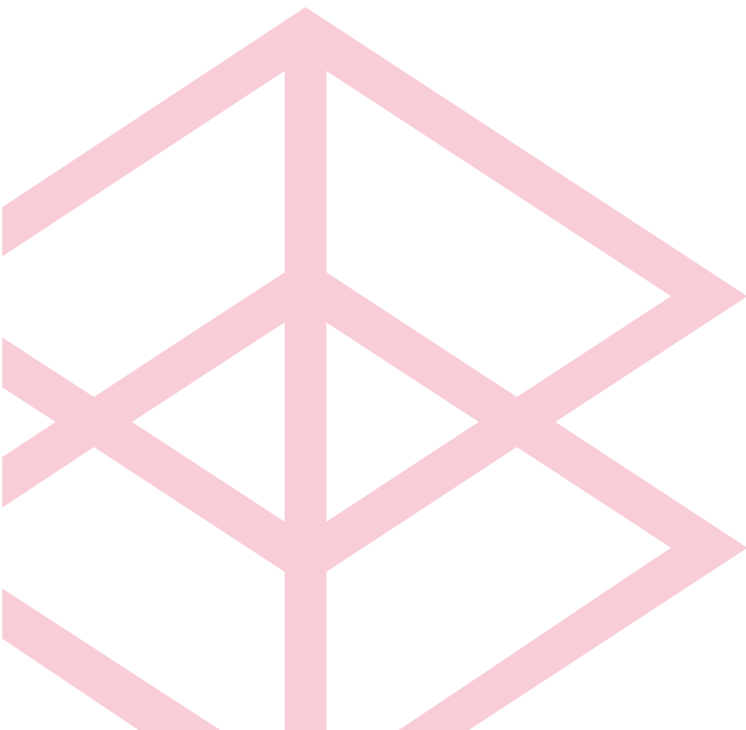



1. Remote control layout

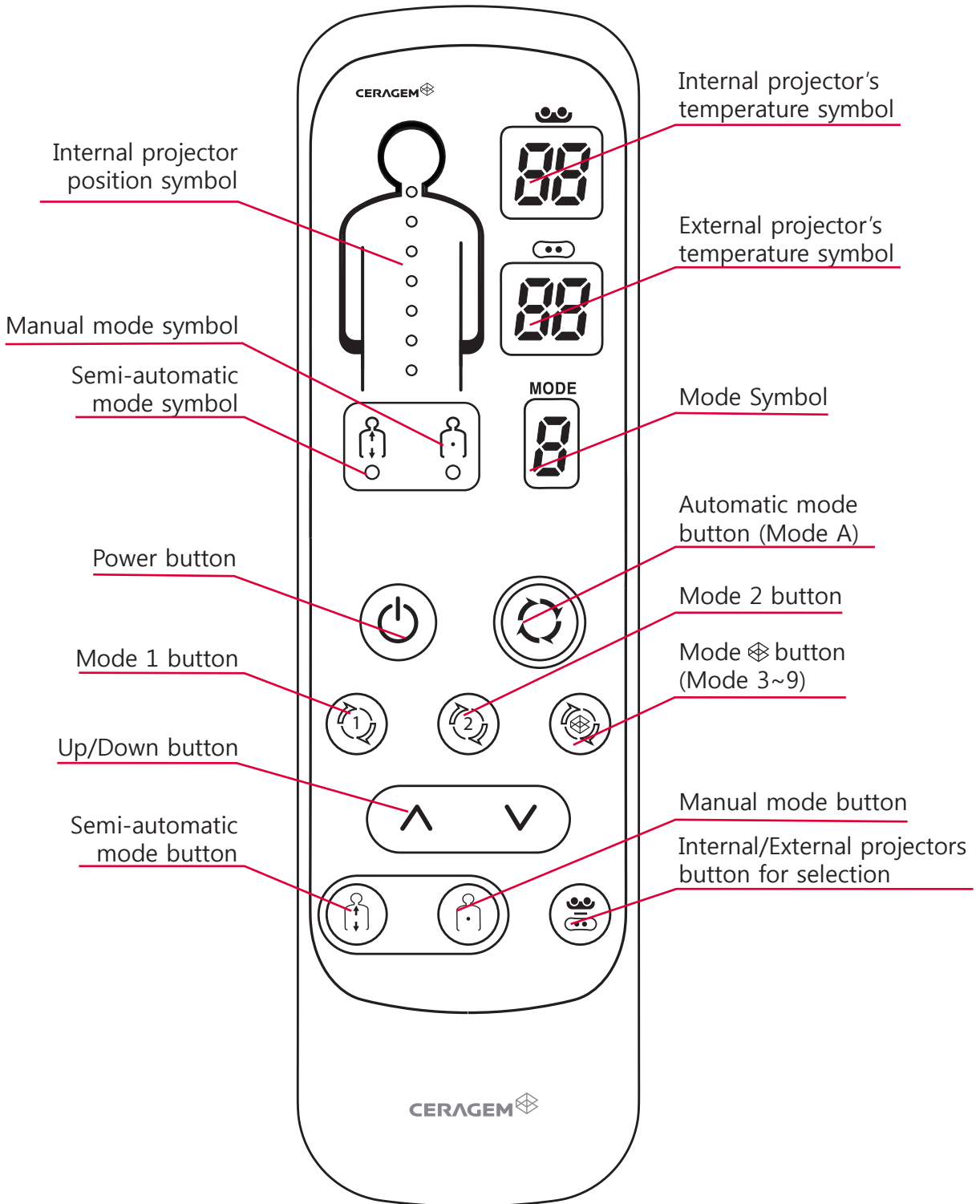



2. How to use the remote control

Turning on the Remote Control

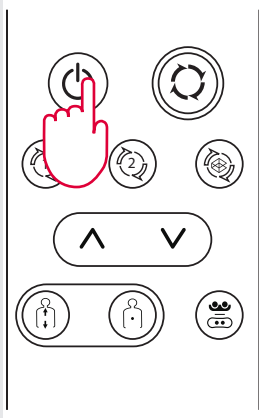

1. Check the condition of the product connections and press the power key of the remote control.

- Start the remote control after opening the auxiliary part.
- Press the remote control for 2~3 seconds to turn it off.

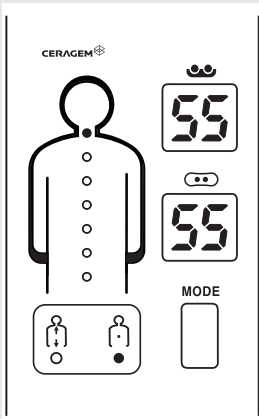

2. Check the display on the remote control.

- External projectors appear only when they are connected.
- The current temperature is displayed, and the standby state is shown.
- Refer to pages 21~26 for the mode selection.
- Refer to page 20 for details on how to adjust the temperature.

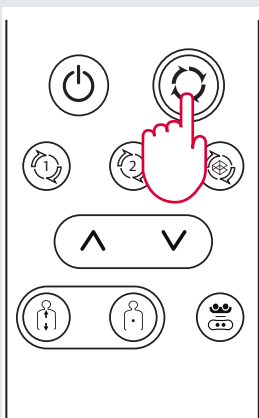

3. Select the mode to be used.



2. How to use the remote control

Adjusting the Temperature

The temperature of the internal projector and external projector can be adjusted when the mode is in use.

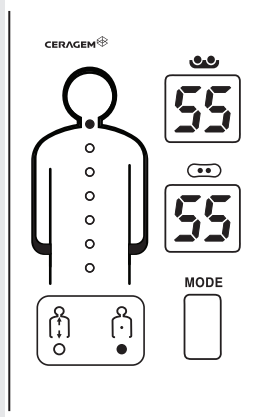

1. Check the current temperature.

- If you press the Internal/External projectors button for selection, the setting temperature display for the projector will flash, and a buzzer sound will be emitted. (The temperature is in standby state.)

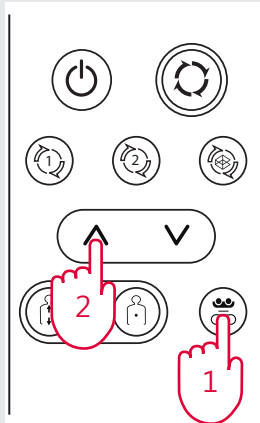

2. Press the temperature key and set the temperature to the desired level using the Up/Down button.

- The temperature can be adjusted by 1°C.
- If you do not press the button for 5 seconds in temperature standby state, the temperature is converted into the current level when the temperature setting is completed.



Pressing once (Internal projector temperature selected)



Pressing repeatedly (External projector temperature selected)

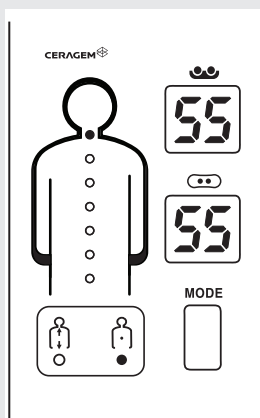

3. Check the changed temperature set point on the remote control display.

- If you do not press the setting button after setting the temperature by pressing the internal/external projectors' temperature, the temperature is converted into the current level after the temperature display blinks for about 5 seconds.



Internal projector

30°C~65°C



External projector

30°C~60°C

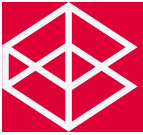

3. How to use the product (by mode)

Automatic Mode (Mode A) (Mode Duration : Approx. 36 minutes 30 seconds)

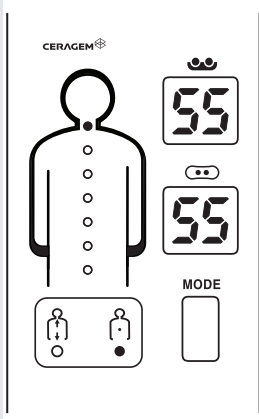

1. Turn on the remote control power and check the display.

- External projectors appear only when they are connected.
- The current temperature is displayed, and the standby state is shown.

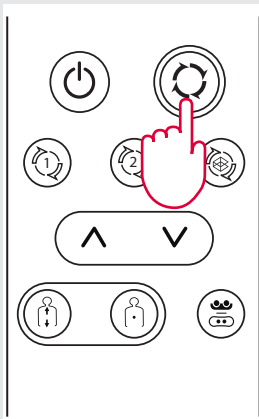

2. Select the mode by pressing the automatic mode button (Mode A).

- The mode display will show "A"
- To change the mode, press the desired mode button once more in 5-second standby state after pressing the mode button.

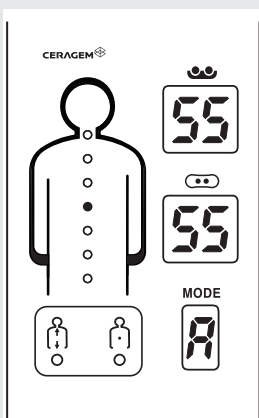
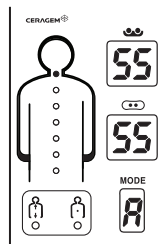

3. The mode begins automatically, and body sensing starts.

Lie in the correct posture.

- When you move the internal projector, the moving projector display appears.
- During body recognition, internal projector position symbols will flash in order.



3. How to use the product (by mode)

Automatic Mode (Mode 1) (Mode Duration: Approx. 36 minutes 30 seconds)

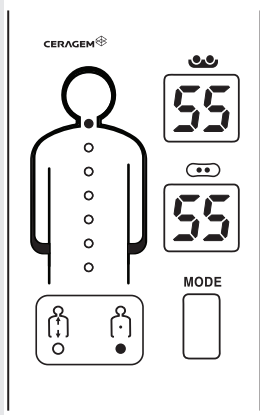

1. Turn on the remote control power and check the display.

- External projectors appear only when they are connected.
- The current temperature is displayed, and the standby state is shown.

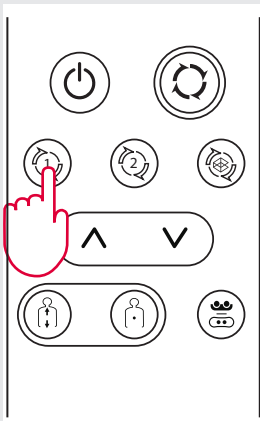

2. Select the mode by pressing the automatic mode 1 button.

- The mode display will show "1."
- To change the mode, press the desired mode button once more in 5-second standby state after pressing the mode button.

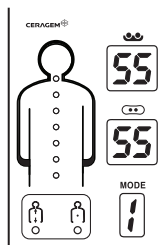

3. The mode begins automatically, and body sensing starts. Lie in the correct posture.

- When you move the internal projector, the moving projector display appears.
- During body recognition, internal projector position symbols will flash in order.

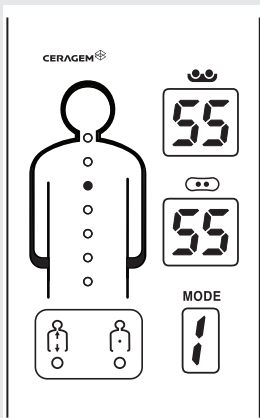



3. How to use the product (by mode)

Automatic Mode (Mode 2) (Mode Duration: Approx. 18 minutes)

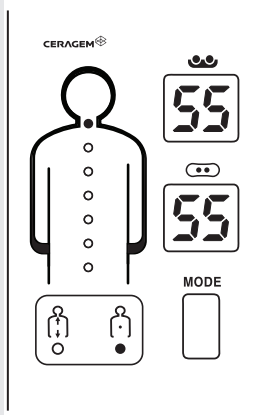

1. Turn on the remote control power and check the display.

- External projectors appear only when they are connected.
- The current temperature is displayed, and the standby state is shown.

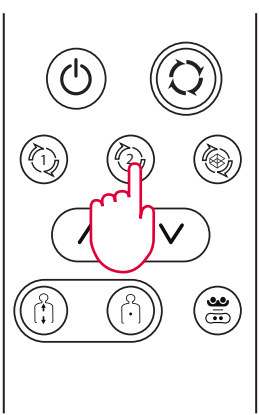

2. Select the mode by pressing the automatic mode 2 button.

- The mode display will show "2."
- To change the mode, press the desired mode button once more in 5-second standby state after pressing the mode button.

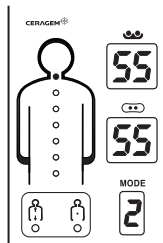

3. The mode begins automatically, and body sensing starts. Lie in the correct posture.

- When you move the internal projector, the moving projector display appears.
- During body recognition, internal projector position symbols will flash in order.



3. How to use the product (by mode)

Modes 3~9 (Mode Duration: Approx. 36 minutes 30 seconds)

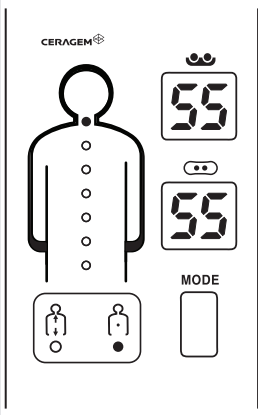

1. Turn on the remote control power and check the display.
 - External projectors appear only when they are connected.
 - The current temperature is displayed, and the standby state is shown.

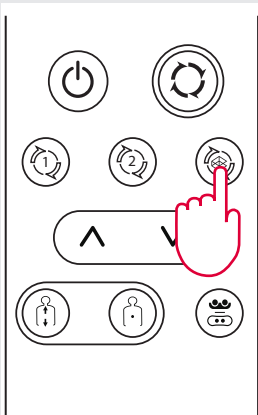

2. Select the mode by pressing the mode button (Modes 3~9).
 - The mode display will show the mode number.
 - To change the mode, press the desired mode button once more in 5-second standby state after pressing the mode button.

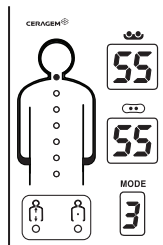

 Pressing repetition
(Modes 3~9 Sequential selection)

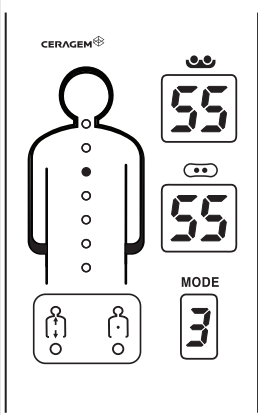

3. The mode begins automatically, and body sensing starts. Lie in the correct posture.
 - When you move the internal projector, the moving projector display appears.
 - During body recognition, internal projector position symbols will flash in order.



3. How to use the product (by mode)

Semi-Automatic Mode (Mode Duration: Approx. 18 minutes)

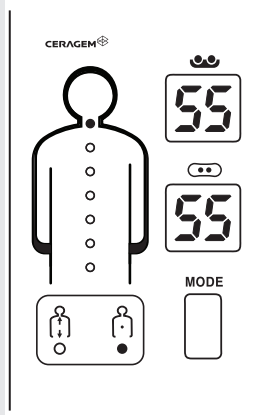

1. Turn on the remote control power and check the display.
 - External projectors appear only when they are connected.
 - The current temperature is displayed, and the standby state is shown.

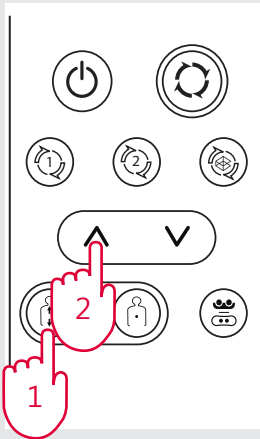

2. Press the semi-automatic button and move the internal projectors to the desired position.

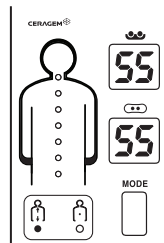

- If you press the semi-automatic mode button, the semi-automatic mode display will flash, and a buzzer sound will be emitted.
- To change the mode, press the desired mode button once more in 5-second standby state after pressing the mode button.

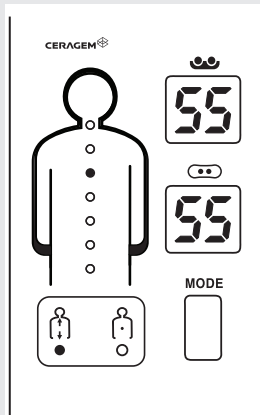

3. The mode will automatically begin centered on the designated position. Assume a proper body posture.
 - Up and Down motion will begin centered on the selected point.
 - When you move the internal projector, the moving projector display appears.



3. How to use the product (by mode)

Manual Mode (Mode Duration: Approx. 60 minutes)

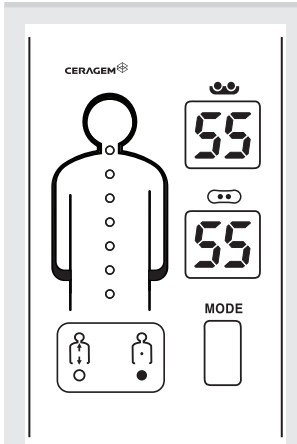

1. Turn on the remote control power and check the display.
 - External projectors appear only when they are connected.
 - The current temperature is displayed, and the standby state is shown.

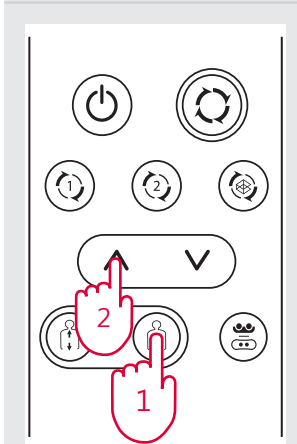

2. Press the manual mode button and move the internal projectors to the desired position.

- If you press the manual mode button, the manual mode display will flash, and a buzzer sound will be emitted.
- To change the mode, press the desired mode button; the mode will then be changed immediately.

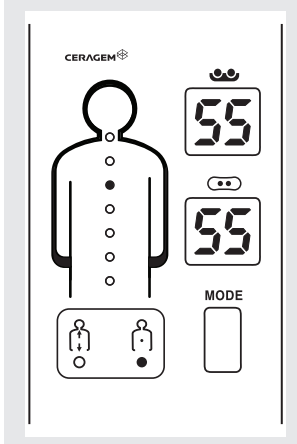
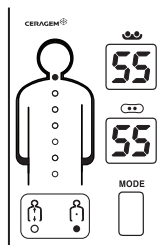

3. Thermal stimulation begins from the designated position. Assume a proper body posture.
 - When you move the internal projector, the moving projector display appears.
 - The projector moves after a certain time (5 minutes) to prevent freeze burn.

* The massage patterns may be adjusted depending on the user's height.



3. How to use the product (by mode)

Mode Pattern

●●●●●● Scanning

● Thermal acupressure (88 seconds)

Mode A

(Mode Duration: Approx. 36 minutes 30 seconds)

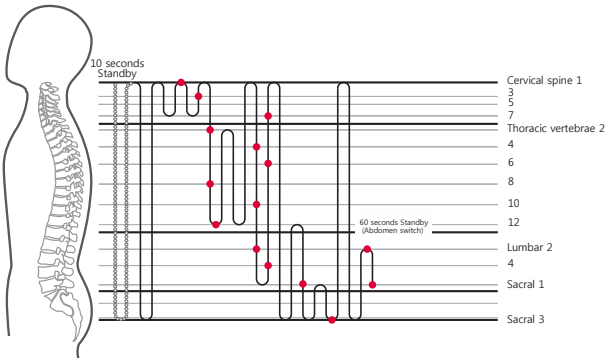

Mode 1

(Mode Duration: Approx. 36 minutes 30 seconds)

● Thermal acupressure (100 seconds)

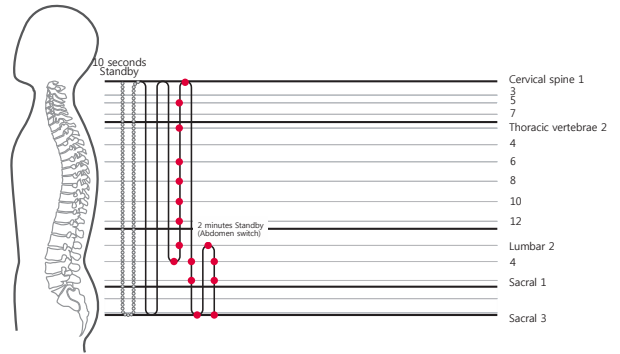

Mode 2

(Mode Duration: Approx. 18 minutes)

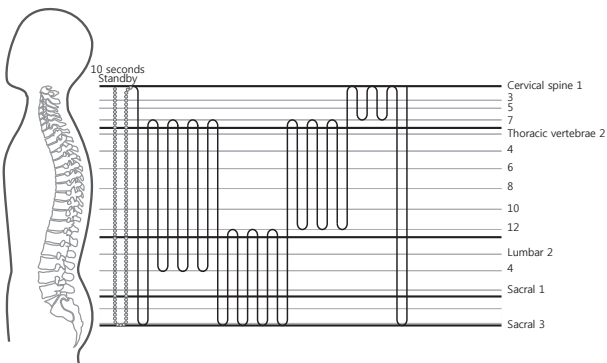

Mode 3

(Mode Duration: Approx. 36 minutes 30 seconds)

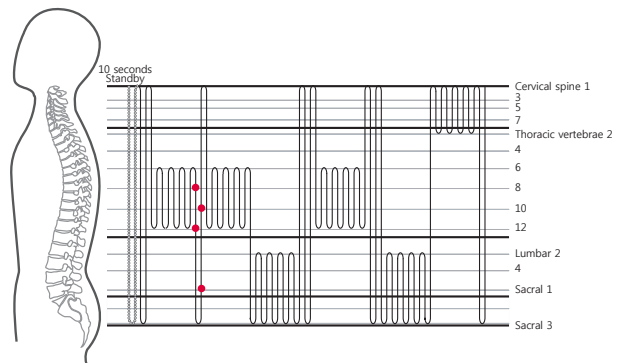

* The massage patterns may be adjusted depending on the user's height.



3. How to use the product (by mode)

Mode Pattern

○○○○○○ Scanning

● Thermal acupressure (88 seconds)

Mode 4

(Mode Duration: Approx. 36 minutes 30 seconds)

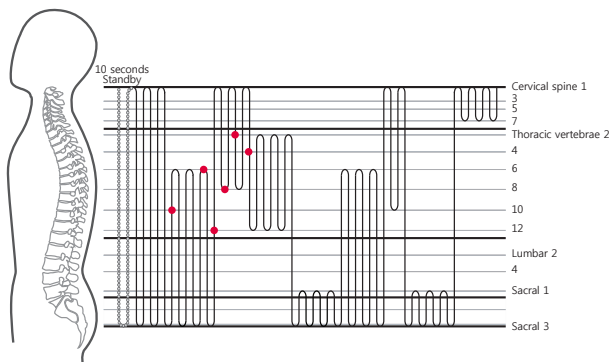

Mode 5

(Mode Duration: Approx. 36 minutes 30 seconds)

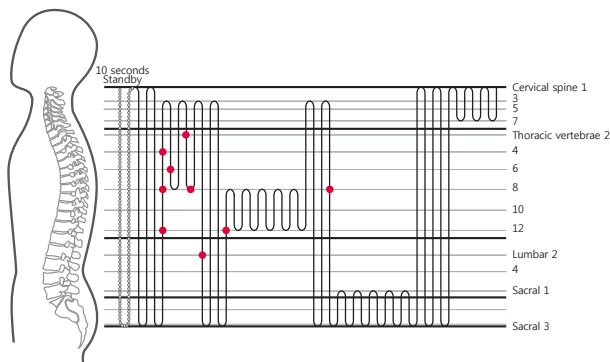

Mode 6

(Mode Duration: Approx. 36 minutes 30 seconds)

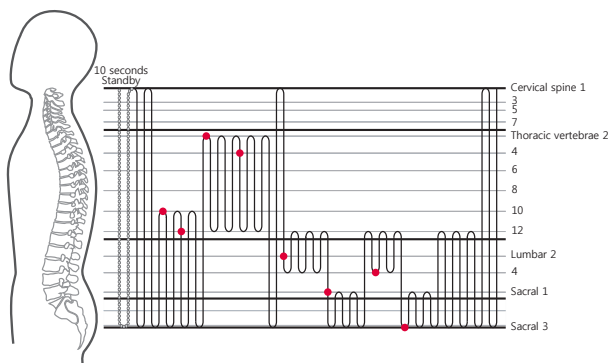

Mode 7

(Mode Duration: Approx. 36 minutes 30 seconds)

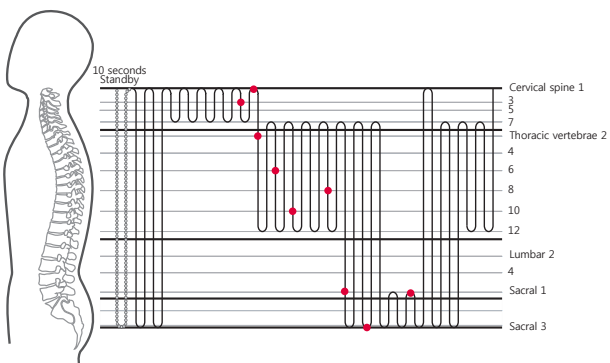

* The massage patterns may be adjusted depending on the user's height.



3. How to use the product (by mode)

Mode Pattern

○○○○○○ Scanning

● Thermal acupressure (88 seconds)

Mode 8

(Mode Duration: Approx. 36 minutes 30 seconds)

Mode 9

(Mode Duration: Approx. 36 minutes 30 seconds)

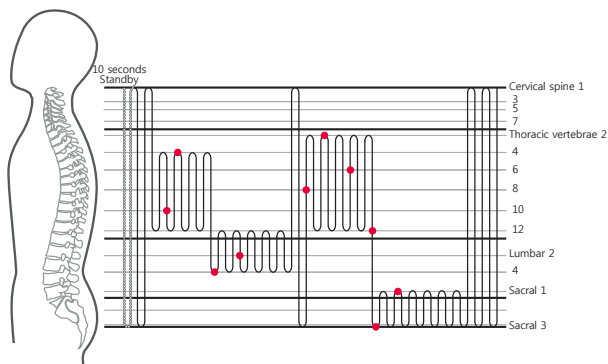
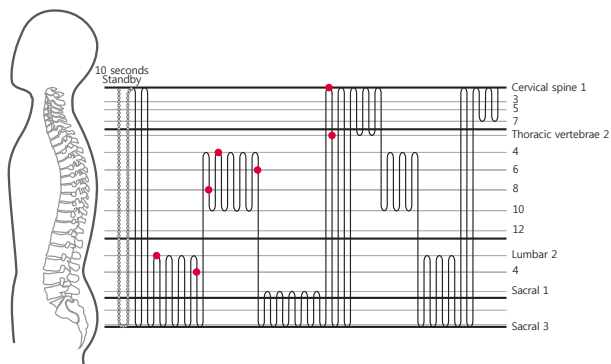

Semi-Automatic Mode

(Mode Duration: Approx. 18 minutes)

Massaging is repeated on a specified region. This region depends on the final position of the internal projectors.

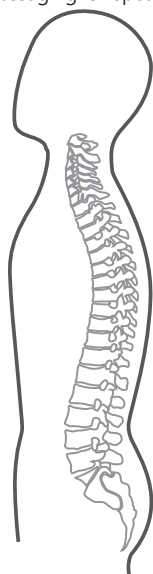

● Up&Down(3 Times) + Thermal acupressure (60 seconds)

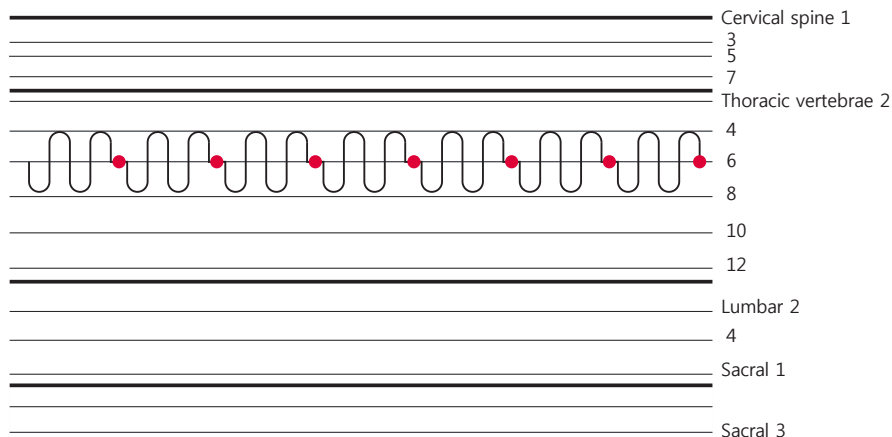

※ Users may adjust the position.

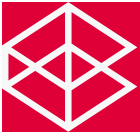

4. How to move the product

1

Close the product using the supporting frame and lock the safety latch.

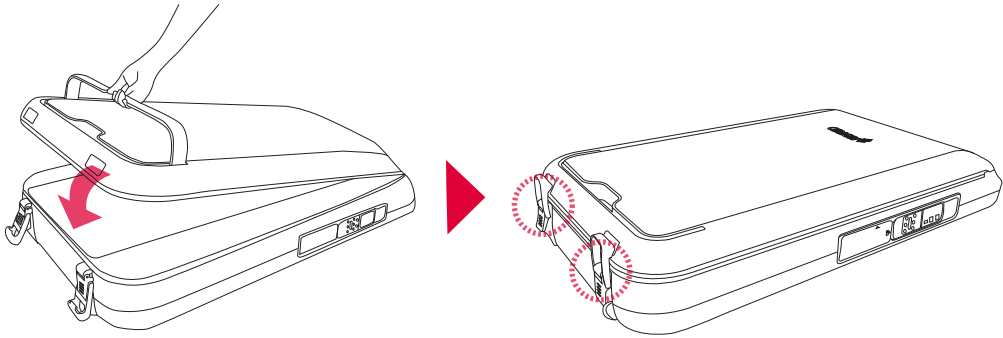

Caution

Take care not to insert any part of your body into the product when closing the product. (There is risk of injury.)

2

Hold the handle and move the product using the casters.



Caution

When you move or store the product, take care not to slam it down. (There is risk of injury and equipment failure.)

IV. Management and matters that require attention

1. Self inspection
2. Management techniques and storage methods
3. Check before A/S request
4. Remote control error messages
5. Product specifications
6. Product warranty





1. Self inspection

Inspection Points Before Use

1. Is the power cord connected to the socket?
2. Did you check whether the main body's power button is "ON"?
3. Is the remote control temperature displayed when the remote control power is "ON"?
4. Did you check whether the projector's temperature has been set to the appropriate level?
5. Is there anything strange on the exterior?
6. Did you check whether there is no damage to the external projector cover?

Inspection Points After Use

1. Did you check whether all displays have been turned "OFF" when the remote control power is "OFF"?
2. Did you check whether the main body's power button is "OFF"?
3. Is the power cord disconnected from the socket?



2. Management techniques and storage methods

1. Leather is an oil based product. Therefore it is crucial that it is not exposed to organic solvents such as acetone, ballpoint pen ink, gasoline, thinners, sweat, mousse, spray, and etc.

2. Where there is direct contact with the head or skin, wipe with a dry cloth.

3. If there is contact with cosmetic products or volatile emulsions and is left for a long time, the surface may peel off so wipe with a dry cloth as soon as possible.

4. When washing the outer cloth, use a neutral detergent and wash alone by hand.

5. If there is contact with hot objects or heat, the leather will curl up so please use caution.

6. Avoid direct sunlight or humid places.
(They can expose the product to bleaching or aging.)

7. Store at room temperature.



3. Check before A/S request

Does the remote control not turn on?

Q: Is the power switch at the bottom of the product turned on?

A: Turn on the power switch.

Q: Is the power cord properly connected?

A: Reconnect the power cord.

Q: Is the remote control properly connected?

A: Reconnect the remote control.

Q : Is the auxiliary part spread out completely?

A : Start the remote control after spreading out the auxiliary part.

Do the external projectors not work?

Q: Are the external projectors properly connected?

A: Reconnect the external projectors.

Is the product malfunctioning?

Q : Can you move the internal projectors using the Up/Down key?

A : The internal projectors can be moved using the Up/Down key only in semi-automatic mode and manual mode.

Q : Does the internal projector move to your head while using the product?

A : If you lift the auxiliary part while using the product, the remote control power turns off. The internal projector moves to your head automatically.

Please use after turning power on again.

Are error messages displayed on the remote control?

Q : Does the remote control screen display E1, E2, E, C, or LE?

A : After checking the error messages, contact the Customer Support Center.

Never dismantle the product arbitrarily.



4. Remote control error messages

In case of error during operation, the following messages appear on the remote control display:

Symbol	Meaning
E1	When the internal projector's temperature is over 75°C, the "E1" error appears on the temperature display of the internal projector, and all operations of the product stop.
E2	When the external projector's temperature is over 70°C, the "E2" error appears on the temperature display of the external projector, and all operations of the product stop.
E	If the motor is overloaded, and certain abnormal current is detected, the "E" error appears on the automatic mode display, and all operations of the product stop.
C	If normal communication between the remote control and the main body is impossible, the "C" error appears on the automatic mode display, and all operations of the product stop.
LE	It appears when the limit switch is faulty and all operations of the product stop.



Caution

After checking the error messages, contact the Customer Support Center.



5. Product specifications

Model	CGM MCB-1201
Article	Automatic Thermal Massager
Voltage	100-240V~, 50/60Hz
Consumption Power	150VA
Environment temperature	10°C~40°C
Recommended Height for Body Sensing	120cm~186cm
Measurement	When spread out : 2080mm x 600mm x 120mm(±5mm) When folded : 1170mm x 600mm x 175mm(±5mm)
Weight (excluding components)	26kg(±2kg)
Maximum Permissible Weight	135kg
Purpose of use	Help to muscle relaxation therapy, temporary relief of minor muscle and joint pain, stiffness, blood circulation.
Manufacturer	CERAGEM CO., LTD

* To improve quality, design and product specifications may be changed without notice.



6. Product warranty

Warranty

- * Ceragem provides warranty on their products, under the Consumer Protection Law.
- * If you purchase a product that has Ceragem's approval, warranty will last for 1 year and component repairs and services will be provided for free.
- * This warranty is only valid in the country that the product has been purchased in.
- * Contact the customer center in case of a breakdown.
- * This product's component parts will be kept for a term of 3 years. Important component parts MOTOR, PCB, projector sliding part (internal projector) and etc. will be kept for a term of 5 years.

Product		Customer's name	
Model		Address 1	
Serial No.		Address 2	
Warranty period	1 year from the date of purchase	Location	
date of purchase		Postal code	
place of purchase		Telephone number	

(The place of purchase for this product must be completed and verified in order to receive services free of charge in the future.)

Service free of charge

You are only eligible to receive service free of charge for a breakdown within 1 year of purchasing the product and with appropriate use of the product. Products used for commercial purposes or used frequently may have shortened warranty periods.

Charged service

In order to provide quick and satisfactory service, we require that customers check the points stated below before requesting service. Services for items stated below will be charged.

- If the product is connected to a socket that is not 100-240V~.
- If the power has not been correctly connected.
- If the consumer did not install the product or use the product properly.
- If depletable component parts (inner cloth, outer cloth, external project cover and etc.) have worn out
- If an error in use has led to a breakdown.
- If breakdowns occur due to natural disasters (floods, burns, earthquakes, falling of a thunderbolt, war and etc.)
- if breakdowns occur when used in an inappropriate environment.

Matters that require attention

If the product breaks down or is damaged as follows, the responsibility is with the customer.

- If the product is repaired by an unofficial technician and causes a breakdown.
- If the product has been randomly repaired or remodeled by the consumer and causes a breakdown.
- If the product is damaged or breaks down due to misuse, abuse or carelessness.

Terms of warranty

This letter of warranty becomes applicable at the time of purchase or contract.

This letter of warranty is valid only to the person who purchased the product, and therefore those who acquired this product by transfer from the initial purchaser will not receive any warranty.

Any other letters of warranty that have not been issued by Ceragem, letters that have been additionally issued by others, or letters that have passed the expiry date are exempt from the terms stated above.



CERAGEM CO., LTD.

177-14, Osaekdang-ri, Seonggeo-eup,
Seobuk-gu, Cheonan-si, Chungcheongnam-do,
331-831, KOREA

Tel : 82-41-523-2550 Fax :82-41-523-2560

MEMO

A series of horizontal dashed lines for writing.

V. Service manual

1. Explanation of mark, delivery, and storage
2. Attached documents

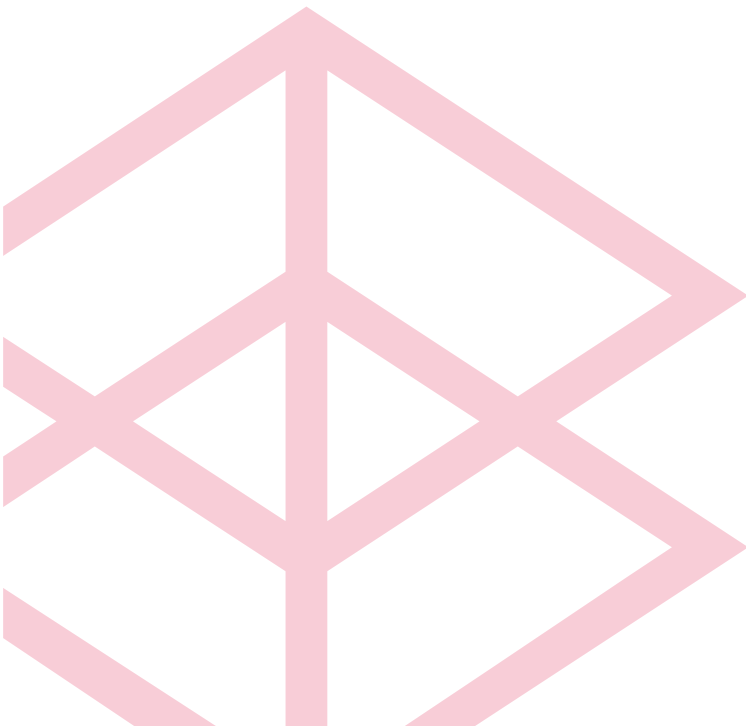

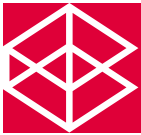

1. Explanation of mark, delivery, and storage

Classification

Form of electric shock protection	CLASS I EQUIPMENT
Degree of electric shock protection	TYPE BF APPLIED PART.
Degree of protection from harmful invasion of water	Ordinary
Depending on the mode of operation	Continuous operation.



Conformite Europeenne Mark.(Medical Devices)



This marking shown on the product or its literature, indicates that it should not be disposed with other household wastes at the end of its working life. To prevent possible harm to the environment or human health from uncontrolled waste disposal, please separate this from other types of wastes and recycle it responsibly to promote the sustainable reuse of material resources.

Household users should contact either the retailer where they purchased this product, or their local government office, for details of where and how they can take this item for environmentally safe recycling

V~ : AC (alternating current) voltage source

○ : Off (power: disconnection from the mains)

| : On (power: connectino to the mains)

⚠ : Attention, consult Accompanying documents



: TYPE BF APPLIED PART



: Handle with Care(Wet)



: Load Way Mark



: Handle with Care(Fragile)



: Handle with Care(Open)



: Serial number Mark



: Manyfacturer Mark



: Refer to instruction manual/booklet sign



: General prohibition sign

The disposal of waste products / residues, etc.

Business users should contact CERAGEM and check the terms and conditions of the purchase contract. This product should not be mixed with other commercial wastes for disposal.

Condition for Transport and Storage

- An ambient temperature range of -20°C to +60°C.
- A relative humidity range of 10% to 95%.
- An atmospheric pressure range of 500hPa to 1060hPa.

Condition for Operation

- An ambient temperature range of +10°C to +40°C.
- A relative humidity range of 30% to 75%.
- An atmospheric pressure range of 700hPa to 1060hPa.

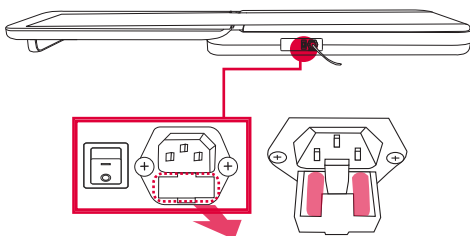

Do not disassemble and contact the customer service center when problem occurs with a fuse.

Capacity of a fuse : AC 250V, T2AL

Time-Lag,
2A,
Glass Body Fuse

* Pull the marked area to exchange the fuse (related to service engineer)

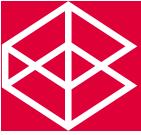

2. Attached documents

Guidance and Manufacturer's declaration - electromagnetic emission

The Model CGM MCB-1201(CERAGEM CO., LTD. Automatic Thermal Massager)is intended for use in the electromagnetic environment specified below.The customer or the user of CGM MCB-1201 should assure that it is used in such an environment

Emission test	Compliance	Electromagnetic environment - guidance
RF emissions CISPR 11	Group 1	The Model CGM MCB-1201 uses RF energy only for its internal function. Therefore. Its RF emissions are very low and are not likely to cause any interference in nearby electronic equipment
	Class B	The Model CGM MCB-1201 is suitable for use in all establishments, including domestic establishments and those directly connected to the public low-voltage power supply network that supplies buildings used for domestic purposes.
Harmonics emission IEC 61000-3-2	A	
Voltage fluctuation IEC 61000-3-3	Complies	



2. Attached documents

Manufacturer's declaration - electromagnetic immunity

The CGM MCB-1201 is intended for use in the electromagnetic environment specified below. The customer or the user of CGM MCB-1201 should assure that it is used in such an environment.			
Immunity test	IEC 60601 Test level	Compliance level	Electromagnetic environment - guidance
Electrostatic discharge (ESD) IEC 61000-4-2	6kV Contact 8kV Air	6kV Contact 8kV Air	Floors should be wood, concrete or ceramic tile. If floors are covered with synthetic material, the relative humidity should be at least 30%.
Electrical fast Transient/burst IEC 61000-4-4	2kV for power supply lines 1kV for input/output lines	2kV for power supply lines 1kV for input/output lines	The main power's quality should be that of a typical commercial or hospital environment.
Surge IEC 61000-4-5	1kV differential mode 2kV common mode	1kV differential mode 2kV common mode	The main power's quality should be that of a typical commercial or hospital environment.
Power frequency (50/60Hz) Magnetic field IEC 61000-4-8	3.0 A/m	3.0 A/m	Power frequency magnetic fields should be at levels characteristic of a typical location in a typical commercial or hospital environment.
	<5% U_T (>95% dip in U_T) for 0.5 cycle	<5% U_T (>95% dip in U_T) for 0.5 cycle	The main power's quality should be that of a typical commercial or hospital environment. If the user of the CERAGEM-CH requires continued operation during power mains interruptions, it is recommended that the CGM MCB-1201 be powered from an uninterruptible power supply or a battery.
	40% U_T (60% dip in U_T) for 5 cycle	40% U_T (60% dip in U_T) for 5 cycle	
	70% U_T (30% dip in U_T) for 25 cycle	70% U_T (30% dip in U_T) for 25 cycle	
	<5% U_T (<95% dip in U_T) for 5 s	<5% U_T (<95% dip in U_T) for 5 s	
Note : U_T is the a.c. mains voltage prior to application of the test level.			



2. Attached documents

The CGM MCB-1201 is intended for use in the electromagnetic environment specified below. The customer or the user of the CGM MCB-1201 should assure that it is used in such an environment.			
Immunity test	IEC 60601 Test level	Compliance level	Electromagnetic environment - guidance
Conducted RF IEC 61000-4-6	3 Vrms 150 kHz to 80 MHz	3 Vrms 150 kHz to 80 MHz	Portable and mobile RF communications equipment should be used no closer to any part of the CGM MCB-1201 including cables, than the recommended separation distance calculated from the equation applicable to the frequency of the transmitter. Recommended separation distance $d = \left[\frac{3,5}{V1} \right] \sqrt{P}$
Radiated RF IEC 61000-4-3	3 V/m 80.0 MHz to 2.5 GHz	3 V/m 80.0 MHz to 2.5 GHz	Recommended separation distance $d = \left[\frac{3,5}{E1} \right] \sqrt{P} \quad 80\text{MHz bis } 800 \text{ MHz}$ $d = \left[\frac{7}{E1} \right] \sqrt{P} \quad 800\text{MHz bis } 2.5 \text{ GHz}$ Where P is the maximum output power rating of the transmitter in watts (W) according to the transmitter manufacturer and d is the recommended separation distance in meters (m). Field strengths from fixed RF transmitters, as determined by an electromagnetic site survey, (a) Should be less than the compliance level in each frequency range (b). Interference may occur in the vicinity of equipment marked with the following symbol: 
<p>Note 1) U_T is the A.C. mains voltage prior to application of the test level.</p> <p>Note 2) At 80 MHz and 800 MHz, the higher frequency range applies.</p> <p>Note 3) These guidelines may not apply in all situations. Electromagnetic propagation is affected by absorption and reflection from structures, objects and people.</p> <p>a Field strengths from fixed transmitters, such as base stations for radio (cellular/cordless) telephones and land mobile radios, amateur radio, AM and FM radio broadcast and TV broadcast cannot be predicted theoretically with accuracy. To assess the electromagnetic environment due to fixed RF transmitters, an electromagnetic site survey should be considered. If the measured field strength in the location in which the EUT is used exceeds the applicable RF compliance level above, the EUT should be observed to verify normal operation. If abnormal performance is observed, additional measures may be necessary, such as re-orienting or relocating the EUT.</p> <p>b Over the frequency range 150 kHz to 80 MHz, field strengths should be less than $[V1] V / m$.</p>			



2. Attached documents

Recommended Separation Distances Between Portable and Mobile RF Communications Equipment and the CGM MCB-1201 .			
The CGM MCB-1201 is intended for use in an electromagnetic environment in which radiated RF disturbances are controlled. The user of the CGM MCB-1201 can help prevent electromagnetic interference by maintaining a minimum distance between portable and mobile RF communications equipment (transmitters) and the CGM MB -1101 as recommended below, according to the maximum output power of the communications equipment.			
Rated maximum output power (W) of transmitter	Separation distance (m) according to frequency of transmitter		
	150 kHz to 80 MHz	80 MHz to 800 MHz	800 MHz to 2.5 GHz
0.01	0.12	0.12	0.23
0.1	0.37	0.37	0.74
1	1.17	1.17	2.33
10	3.70	3.70	7.37
100	11.70	11.70	23.30
For transmitters rated at a maximum output power not listed above, the recommended separation distance (d) in meters (m) can be estimated using the equation applicable to the frequency of the transmitter, where P is the maximum output power rating of the transmitter in watts (W) according to the transmitter manufacturer.			
Note 1: At 80 MHz and 800 MHz, the separation distance for the higher frequency range applies			
Note 2: These guidelines may not apply in all situations. Electromagnetic propagation is affected by absorption and reflection from structures, objects, and people.			

Immunity and Compliance Level			
Immunity test	IEC 60601 Test Level	Actual Immunity Level	Compliance Level
Conducted RF IEC 61000-4-6	3 Vrms, 150 kHz to 80 MHz	3 Vrms, 150 kHz to 80 MHz	3 Vrms, 150 kHz to 80 MHz
Radiated RF IEC 61000-4-3	3 V/m, 80 MHz to 2.5 GHz	3 V/m, 80 MHz to 2.5 GHz	3 V/m, 80 MHz to 2.5 GHz



2. Attached documents

Manufacturer's declaration - electromagnetic immunity

<p>The CGM MCB-1201 is intended for use in the electromagnetic environment specified below.</p> <p>The customer or the user of the CGM MCB-1201 should assure that it is used in such an environment</p>			
Immunity test	IEC 60601 Test level	Compliance level	Electromagnetic environment - guidance
Conducted RF IEC 61000-4-6	3 Vrms 150 kHz to 80MHz	3 Vrms 150 kHz to 80 MHz	CGM MCB-1201 must be used only in a shielded location with a minimum RF shielding effectiveness and, for each cable that enters the shielded location with a minimum RF shielding effectiveness and, for each cable that enters the shielded location
Radiated RF IEC 61000-4-3	3 V/m 80.0 MHz to 2.5 GHz	3 V/m 80.0 MHz to 2.5 GHz	Field strengths outside the shielded location from fixed RF transmitters, as determined by an electromagnetic site survey, should be less than 3V/m. ^a Interference may occur in the vicinity of equipment marked with the following symbol: 
<p>Note 1) These guidelines may not apply in all situations. Electromagnetic propagation is affected by absorption and reflection from structures, objects and people.</p>			
<p>Note 2) It is essential that the actual shielding effectiveness and filter attenuation of the shielded location be verified to assure that they meet the minimum specification.</p>			
<p>a- Field strengths from fixed transmitters, such as base stations for radio (cellular/cordless) telephones and land mobile radios, amateur radio, AM and FM radio broadcast and TV broadcast cannot be predicted theoretically with accuracy. To assess the electromagnetic environment due to fixed RF transmitters, an electromagnetic site survey should be considered. If the measured field strength outside the shielded location in which the EUT is used exceeds 3V/m, the EUT should be observed to verify normal operation. If abnormal performance is observed, additional measures may be necessary, such as relocating the EUT or using a shielded location with a higher RF shielding effectiveness and filter attenuation.</p>			

MEMO

A series of horizontal dashed lines for writing.

MEMO

A series of horizontal dashed lines for writing.

CERAGEM 



CERAGEM CO., LTD.

177-14, Osaekdang-ri, Seonggeo-eup,
Seobuk-gu, Cheonan-si, Chungcheongnam-do,
331-831, KOREA
Tel : 82-41-523-2550 Fax : 82-41-523-2560